

M12 STEEL MALE 0° /M12 STEEL FEMALE 0°

TPE-S-OB 4X0.34 GRAY, 0.6m

F&B-Steel

Male straight – female straight

M12 – M12, 4-pole

Further cable lengths on request.

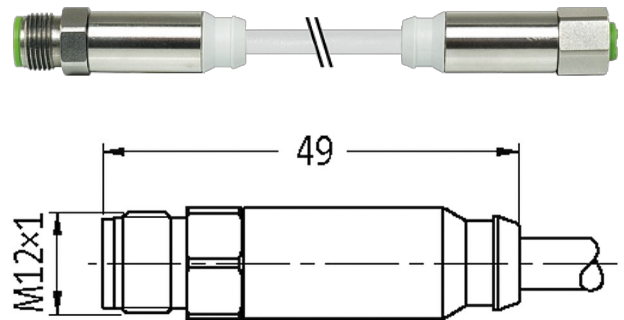
[Link to Product](#)**Illustration**

Product may differ from Image

Approvals

cCSAus

* only for products with UL/CSA approved cable

Form

Form 40021

General data

Temperature range -40...+85 °C, depending on cable quality

Cables

No./diameter of wires	4 × 0.34 mm ²
Wire isolation	TPE-S (br, wh, bl, bk)
Material (jacket)	TPE-S
Outer Ø	5.2 mm ±5%
Temperature range (mobile)	-30...+105 °C
Bend radius (moving)	15 × outer Ø
Temperature range (fixed)	-50...+125 °C
Cable identification	336
Cable weight [g/m]	43,01
Material (wire)	Cu wire, bare
Resistor (core)	max. 57 Ω/km (20 °C)
Single wire Ø (core)	0.05 mm
Construction (core)	180 × 0.05 mm (multi-strand wire class 6)
Diameter (core)	4 × 0.34 mm ²
AWG	similar to AWG 22
Material (wire isolation)	TPE-S

Shore hardness (wire isolation)	90 ±5 A
Wire-Ø incl. isolation	1.5 mm ±5%
Color/numbering of wires	br, bk, bl, wh
Stranding combination	4 wires twisted
Shield	no
Material (jacket)	TPE-S
Shore hardness (jacket)	80 ±5 A
Outer-Ø (jacket)	5.2 mm ±5%
Color (jacket)	gray
Test voltage	2500 V AC
Temperature range (fixed)	-50...+125 °C
Temperature range (mobile)	-30...+105 °C
Bend radius (fixed)	10× outer Ø
Bend radius (moving)	15× outer Ø
Jacket Color	gray

Technical Data

Operating voltage	max. 32 V AC/DC
Operating current per contact	max. 4 A
Locking of ports	Screw thread (M12×1 mm) recommended torque 0.6 Nm, self-securing
Protection	IP68, IP69K inserted and tightened (EN 60529)
Locking material	Stainless steel 1.4404 (V4A)

Commercial data

country of origin	CZ
customs tariff number	85444290
EAN	4048879107631
eClass	27279218
Packaging unit	1

Sketch

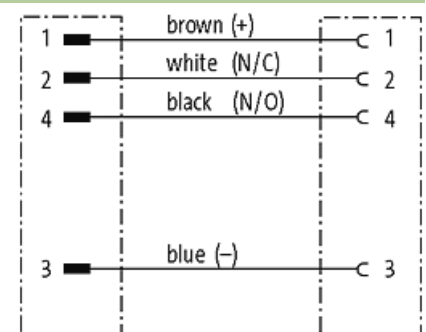

Male

Female

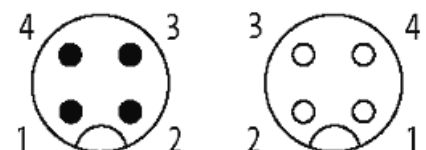

Product may differ from Image